

HOBAS Closure Coupling

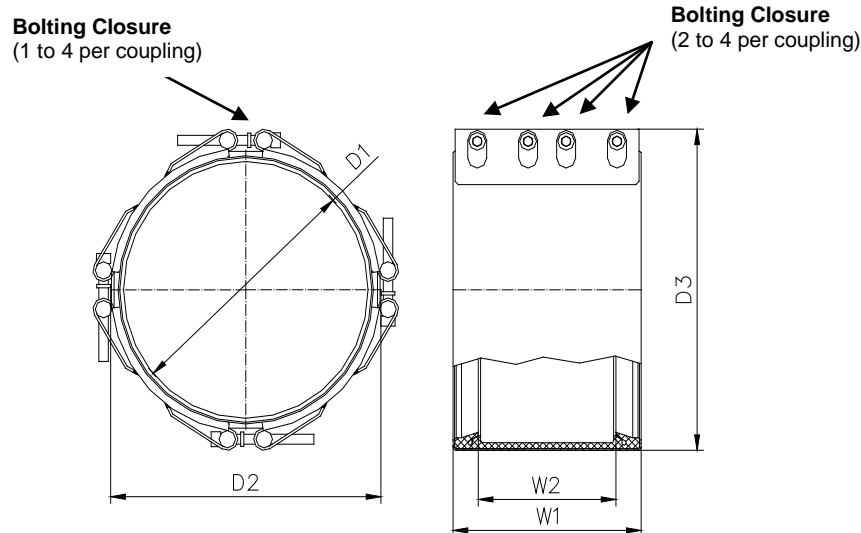

Components / Materials	W4 or W5
Casing	AISI 304 / 316SS
Screws	AISI 316 / 316L or equal
Bolts	AISI 316 / 316L or equal
Sealing sleeve	EPDM / NBR

Pipe Diameters			Working Pressures PSI	Coupling Details						Bolt Closures per Coupling	Bolts per Closure
ND	Min	Max		D1	D2	D3	W1	W2	LBS		
18	19.50	19.53	87	19.53	20.64	21.81	5.5	3.6	14	1	2
20	21.60	21.62	87	21.62	22.73	23.90	5.5	3.6	16	1	2
24	25.79	25.82	72.5	25.82	27.48	28.66	8.3	4.7	35	1	3
27	27.94	27.97	72.5	27.97	29.63	30.81	8.3	4.7	37	1	3
28	29.97	30.01	58	30.01	31.67	32.85	8.3	4.7	40	1	3
30	32.01	32.05	58	32.05	33.71	34.89	8.3	4.7	42	1	3
33	33.97	34.01	58	34.01	35.67	36.85	8.3	4.7	44	1	3
36	38.29	38.34	58	38.34	40.00	41.18	8.3	4.47	49	1	3
41	42.84	42.90	58	42.90	44.56	45.74	8.3	4.7	55	1	3
42	44.47	44.53	58	44.53	46.19	47.37	8.3	4.7	56	1	3
44	45.84	45.89	58	45.89	47.55	48.73	8.3	4.7	58	1	3
45	47.64	47.60	58	47.60	49.26	50.44	8.3	4.7	60	1	3
48	50.76	50.82	58	50.82	52.48	54.84	8.3	4.7	67	2	3
51	53.87	53.93	43.5	53.93	55.59	57.95	8.3	4.7	75	2	3
54	57.05	57.11	43.5	57.11	58.77	61.13	8.3	4.7	82	2	3
57	59.97	60.04	43.5	60.04	61.70	64.06	8.3	4.7	89	2	3
60	62.84	62.92	43.5	62.92	64.58	66.94	12.2	8.7	147	2	4
63	65.96	66.03	43.5	66.03	67.69	70.05	12.2	8.7	151	2	4
66	69.12	69.20	43.5	69.20	70.86	73.22	12.2	8.7	160	2	4
69	72.43	72.51	43.5	72.51	74.17	76.53	12.2	8.7	169	2	4
72	75.37	75.45	43.5	75.45	77.11	79.47	12.2	8.7	173	2	4
78	81.53	81.62	43.5	81.62	85.64	85.64	12.2	8.7	204	4	4
84	86.89	86.98	36	86.98	91.00	91.00	12.2	8.7	217	4	4
85	88.46	88.55	36	88.55	92.57	92.57	12.2	8.7	221	4	4
90	94.12	94.32	36	94.32	98.34	98.34	12.2	8.7	229	4	4
96	99.42	99.52	36	99.52	103.5	103.5	12.2	8.7	237	4	4
104	107.9	108.1	36	108.1	112.1	112.1	12.2	8.7	253	4	4
110	113.9	114.2	36	114.2	118.4	118.4	12.2	8.7	265	4	4
120	125.9	126.2	26	126.2	130	130	12.2	8.7	291	4	4
126	131.5	132.3	26	132.3	137	137	12.2	8.7	307	4	4

HOBAS Closure Coupling Fitting Instructions

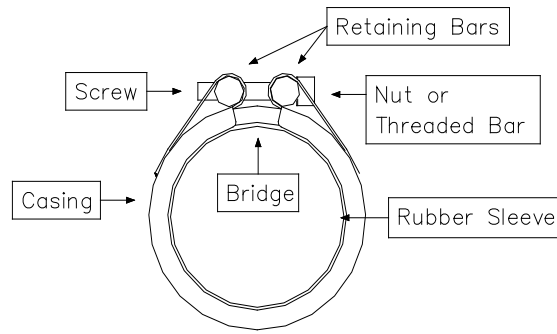

Important
Please read fitting instructions thoroughly before installing coupling

Before Installing

1. Keep the couplings clean. If possible, leave in packaging until required.
2. Clean end of pipes. Remove any surface dirt etc.
3. Mark pipe ends with chalk or crayon in a suitable position as shown below.
4. Lubricate pipe ends with a lubricant suitable for pipeline usage.
5. Do NOT disassemble the coupling! (B)

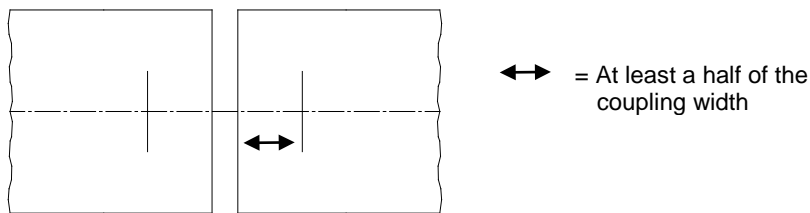

Fitting Procedure

6a EITHER

1. Slide the coupling over the end of one pipe (B, C)
2. Butt the second pipe against the first pipe (C)
3. Slide the coupling back over the pipe end with the chalk mark on the first pipe visible.
4. Ease out the second pipe so that the chalk marks on both pipes are visible.

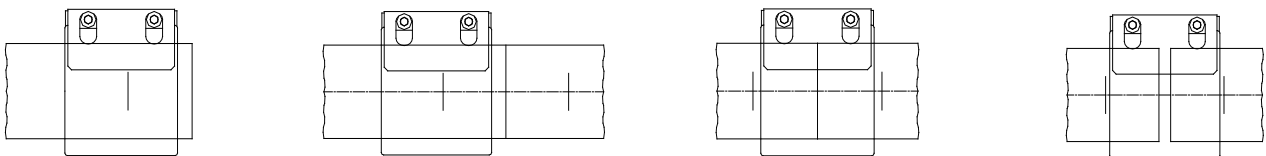

6b

1. Slide the coupling over end of one pipe as far as the mark (B).
2. Push the other pipe into the coupling and adjust so that the chalk marks are clearly visible (C, A).

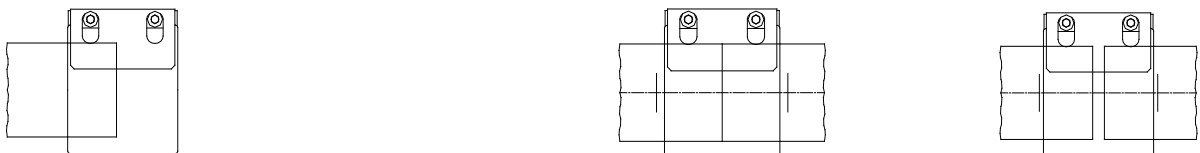

Tightening Procedure

7. Tighten the screws evenly with a torque wrench using a 10mm or 14mm allen key. Set the torque wrench to the torque setting detailed on the label. (D) Installation should be completed in one operation.

8a. Two Screwed Coupling

Tighten the 1st screw until it bites, then tighten the 2nd screw bringing the retaining bars parallel. Continue tightening in cycles (E).

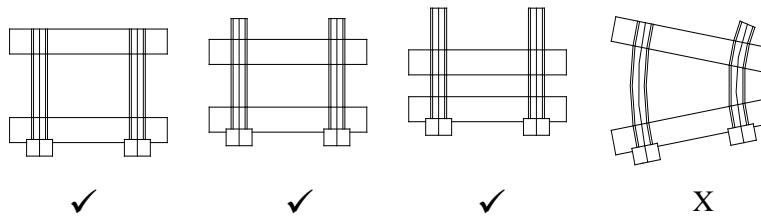

8b. Three/Four Screwed Coupling

Three: tighten the middle screw until it bites. Then tighten the 2 outer screws bringing the retaining bars parallel. Continue tightening in cycles (F). Four: tighten the 2 outer screws first until they bite. Then tighten the 2 inner screws. Continue tightening in cycles.

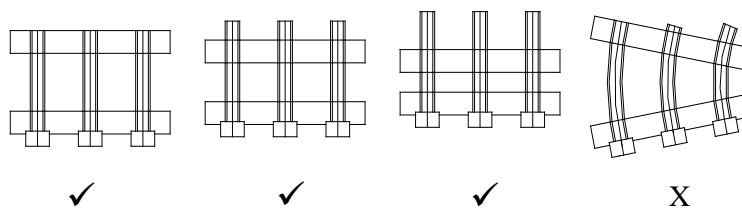

8c. Two (Four) Part Coupling

Two Part: Tighten the screws (as above **8b**) to take up the slack on 1 lockpart then repeat on the opposite lockpart. Continue tightening in cycles going from 1 lockpart to the other, tightening both sides evenly (E).

Four Part: Tighten the screws (as above **8b**) to take up the slack in 2 opposite lockparts the other two lockparts. Continue tightening in cycles going from the first two lockparts to the other two lockparts, tightening all four lockparts evenly.

9. Continue tightening procedure until the torque value is reached (E).

After Tightening

10. Check that the retaining bars are fairly parallel (F).
11. Check that the coupling is square to the pipe and that the pipes are properly aligned (G).
12. Check the rubber sleeve for good compression all round the coupling and on both sides (I).
13. If required, protect the coupling against corrosion using an approved wrapping, sleeving or cathodic system.
14. Make sure that the pipes are adequately anchored and supported to prevent movement beyond the capabilities of the couplings (I).
15. Test the installation. See (J).

Installation Notes

A. Use the distance between the marks on each pipe to establish any pipe gaps, but not beyond the sealing capability of the coupling. Centre the coupling about the marks. The recommended maximum gaps are as follows:

<u>Pipe Size</u>	<u>Coupling Width</u>	<u>Maximum Gap</u>
12" – 18" ND	5.5"	0.5"
24" – 57" ND	8.3"	1.0"
60" – 126" ND	12.2"	1.5"

- B. To aid fitting, the screws may be loosened but not disengaged from the nut or bar.
- C. Make sure that the 2 pipes are straight and not misaligned. Adjust if necessary. Check that any ovality in the pipes is in the same direction. The maximum step between the pipe outside diameters at any point around the pipe circumference should not be greater than 0.1" (sizes up to 24" ND) or 0.2" (sizes over 24" ND). Adjust or jack out if necessary.
- D. The sealing of the rubber sleeve will be improved by tapping all round the casting with a soft nosed mallet during the tightening procedure. This is strongly recommended for all diameters over 24" ND and/or on rough or out of round pipes.
- E. The torque is reached when the torque wrench clicks off simultaneously on ALL screws.
- F. After tightening, if the bars are more than 3-4 degrees out of parallel undo the coupling, check the diameters of the 2 pipes and their alignment and if satisfied carefully refit the coupling.
- G. If the coupling is askew, or if the pipes have moved during installation, undo the coupling, realign the coupling and/or pipes and carefully refit the couplings.
- H. Any gap between the pipe surface and the rubber sleeve suggests poor compression. Check the pipe surface for deformation and pipe alignment and carefully refit the couplings (see notes C, C, E).

- I. The amount of movement which a coupling can accommodate is detailed in the brochures. Pipes must be prevented from moving beyond the recommended values (A). Avoid situations which would create excessive shear conditions. The maximum amount of angular deflection which the couplings can accommodate is as follows:

<u>Pipe Size</u>	<u>Coupling Width</u>	<u>Maximum Angle of Deflection</u>
12" – 20" ND	5.5"	5°
24" – 27" ND	8.3"	5°
28" – 45" ND	8.3"	3°
48" – 57" ND	8.3"	2°
60" – 85" ND	12.2"	2°
90" – 126" ND	12.2"	1°

- J. Couplings may be tested to 1 ½ times the working pressure detailed on the label. If higher test or working pressures are required contact manufacturer.